

OVERVIEW

The H10720 and H10721 series are photosensor modules containing a metal package PMT and a high-voltage power supply circuit. The built-in PMT uses a metal package with the same diameter as a TO-8 metal package used for semiconductor photodetectors. Despite the small size nearly equal to photodiodes, this PMT delivers high gain, wide dynamic range, and high-speed response. Six types of products are available with different sensitivity characteristics such as spectral response ranges. Hamamatsu also provides "P" type with low dark count selected for photon counting measurement. The H10720 series are pin output type, while the H10721 are flexible cable output type.

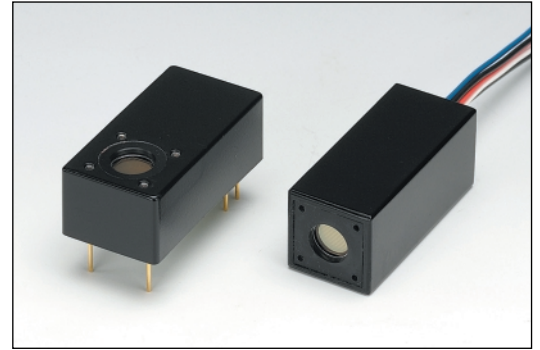

PRODUCT VARIATIONS

● Pin output type (On-board type)

Type No.	Spectral response	Photocathode	Window material	Notes
H10720-110 / H10720P-110	230 nm to 700 nm	Super bialkali	Borosilicate glass	P Type: For photon counting
H10720-113 / H10720P-113	185 nm to 700 nm	Super bialkali	UV glass	
H10720-210 / H10720P-210	230 nm to 700 nm	Ultra bialkali	Borosilicate glass	
H10720-01 / H10720P-01	230 nm to 870 nm	Multialkali	Borosilicate glass	
H10720-04 / H10720P-04	185 nm to 870 nm	Multialkali	UV glass	
H10720-20	230 nm to 920 nm	Extended red multialkali	Borosilicate glass	

● Cable output type

Type No.	Spectral response	Photocathode	Window material	Notes
H10721-110 / H10721P-110	230 nm to 700 nm	Super bialkali	Borosilicate glass	P Type: For photon counting
H10721-113 / H10721P-113	185 nm to 700 nm	Super bialkali	UV glass	
H10721-210 / H10721P-210	230 nm to 700 nm	Ultra bialkali	Borosilicate glass	
H10721-01 / H10721P-01	230 nm to 870 nm	Multialkali	Borosilicate glass	
H10721-04 / H10721P-04	185 nm to 870 nm	Multialkali	UV glass	
H10721-20	230 nm to 920 nm	Extended red multialkali	Borosilicate glass	

This product can't be used at vacuum environment or reduced pressure environment.

Figure 1: Typical spectral response

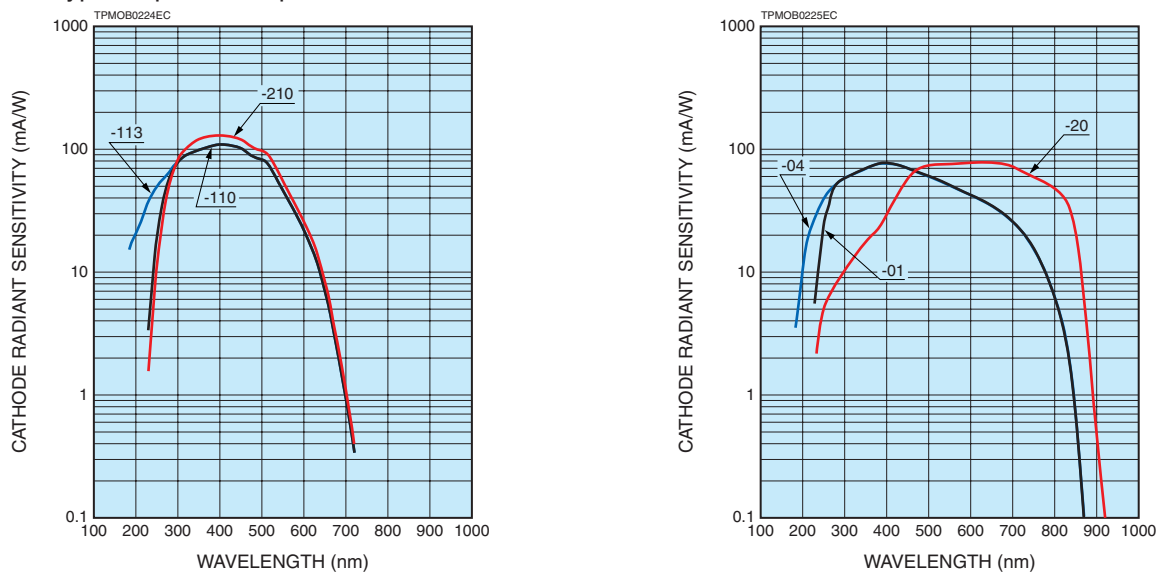

PHOTOSENSOR MODULES H10720/H10721 SERIES

Figure 2: Schematic diagram

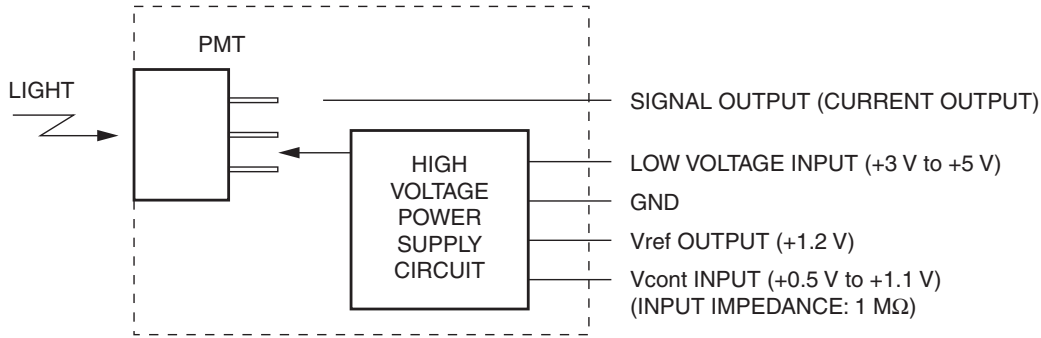

TPMOC0261EA

SPECIFICATIONS

(at +25 °C)

Parameter		H10720 / H10721 series				Unit		
Suffix		-110, -113	-210	-01, -04	-20	—		
Input voltage		+2.8 to +5.5				V		
Max. input voltage		+5.5				V		
Max. input current *1		2.7				mA		
Max. average output signal current *2		100				μA		
Max. control voltage		+1.1 (Input impedance 1 MΩ)				V		
Recommended control voltage adjustment range		+0.5 to +1.1 (Input impedance 1 MΩ)				V		
Effective area		φ8				mm		
Peak sensitivity wavelength		400	400	400	630	nm		
Cathode	Luminous sensitivity	Min.	80	100	100	350	μA/lm	
		Typ.	105	135	200	500		
	Blue sensitivity index (CS 5-58)	Typ.	13.5	15.5	—	—	—	
	Red / White ratio	Typ.	—	—	0.2	0.45	—	
Radiant sensitivity *3		Typ.	110	130	77	78	mA/W	
Anode	Standard type	Luminous sensitivity *2	Min.	80	100	100	350	A/lm
			Typ.	210	270	400	1000	
	Radiant sensitivity *2 *3	Typ.	2.2×10^5	2.6×10^5	1.5×10^5	1.5×10^5	A/W	
		Dark current *2 *4	Typ.	1	1	1	10	nA
	Max.	10	10	10	100			
P type dark count *2 *4	Typ.	50	50	600	—	s ⁻¹		
Max.	100	100	1000	—				
Rise time *2		0.57				ns		
Ripple noise *2 *5 (peak to peak)		Max.	0.1			mV		
Settling time *6		Max.	10			s		
Operating ambient temperature *7		+5 to +50				°C		
Storage temperature *7		-20 to +50				°C		
Weight		Typ.				45 (H10720 series), 80 (H10721 series)	g	

*1: At +5 V input voltage, +1.0 V control voltage, and output current equal to dark current

*2: Control voltage = +1.0 V

*3: Measured at the peak sensitivity wavelength

*4: After 30 minutes storage in darkness.

*5: Cable RG-174/U, Cable length 450 mm, Load resistance = 1 MΩ, Load capacitance = 22 pF

*6: The time required for the output to reach a stable level following a change in the control voltage from +1.0 V to +0.5 V.

*7: No condensation

Figure 3: Sensitivity adjustment method

VOLTAGE PROGRAMMING

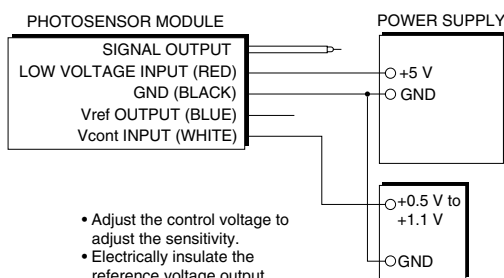

RESISTANCE PROGRAMMING

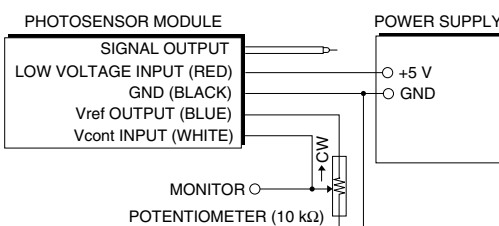

* When using a potentiometer, adjust sensitivity while monitoring the control voltage so it does not exceed +1.1 V.

** When input voltage is +4 V or less, please set resistance of potentiometer to 100 kΩ.

TPMOC0231EB

Figure 4: Typical gain

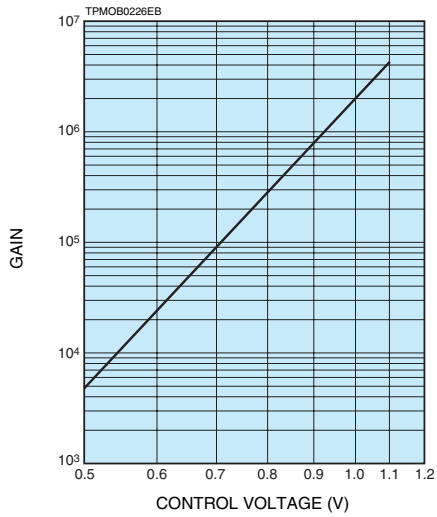

Figure 5: Typical output current v.s. input current

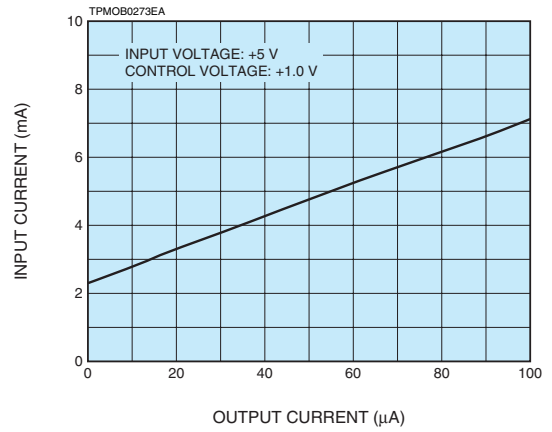

Figure 6: Typical ripple noise

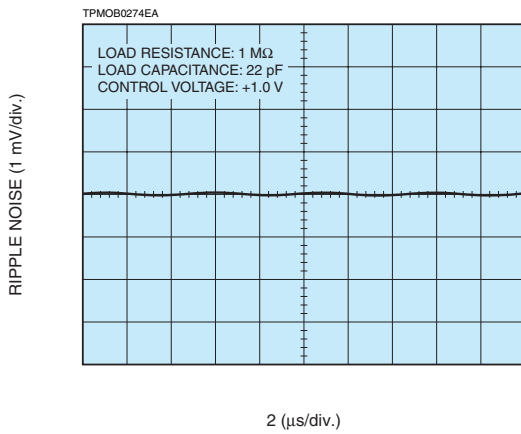
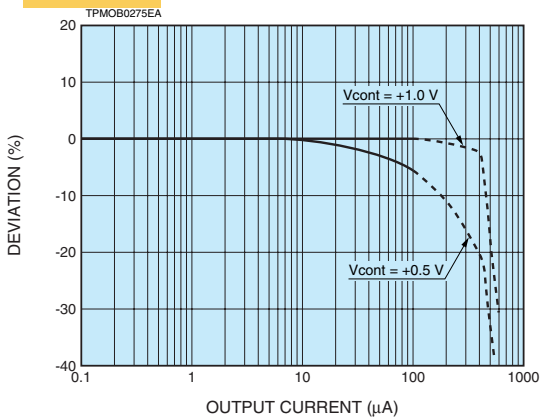

Figure 7: Typical DC linearity

● **H1072x-110/H1072x-210/H1072x-113**



● **H1072x-01/H1072x-20/H1072x-04**

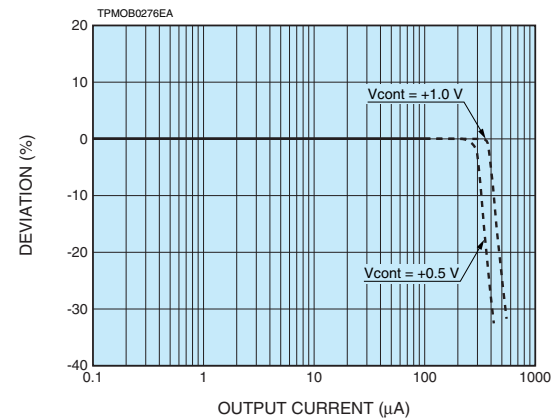
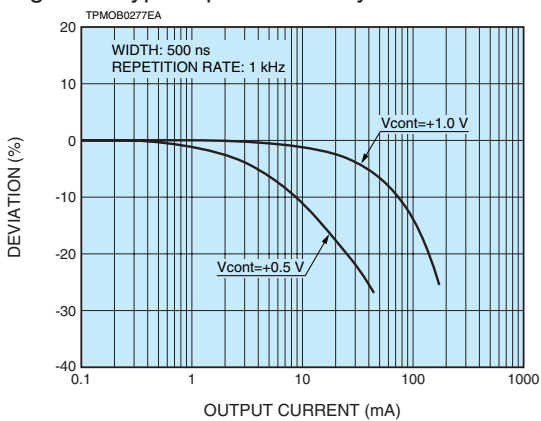
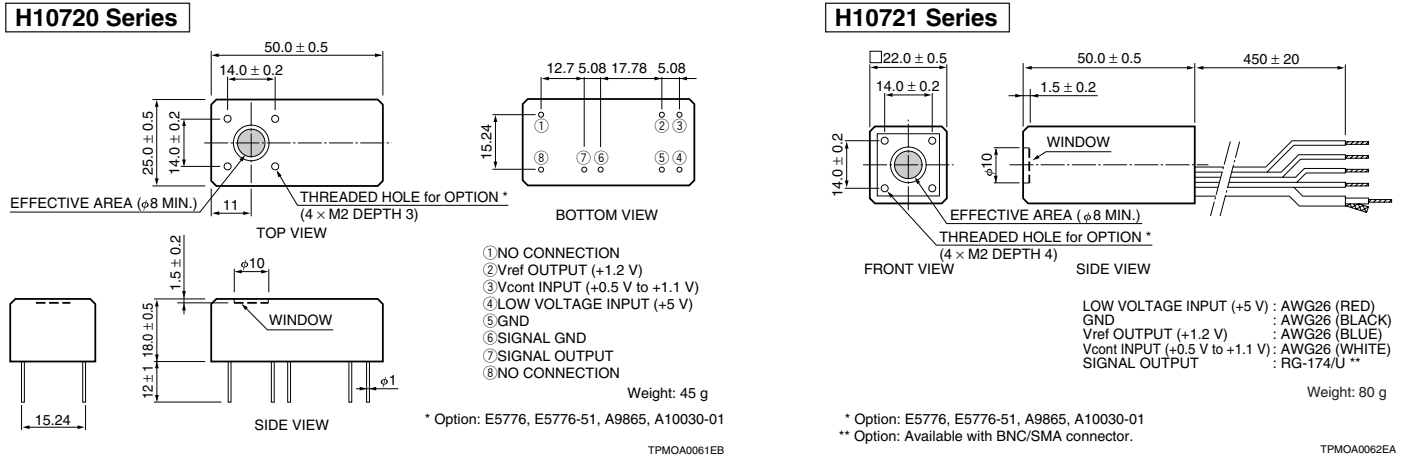

Figure 8: Typical pulse linearity



PHOTOSENSOR MODULES H10720/H10721 SERIES

Figure 9: Dimensional outlines (Unit: mm)



OPTION

OPTICAL FIBER ADAPTER E5776 / E5776-51

E5776 (FC Type)

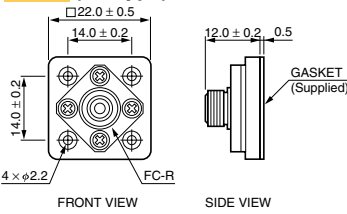

E5776-51 (SMA Type)

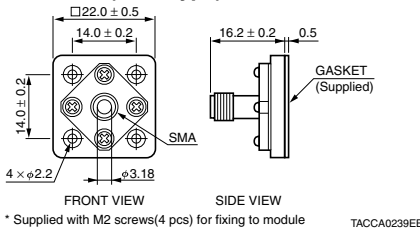

C-MOUNT ADAPTER A9865

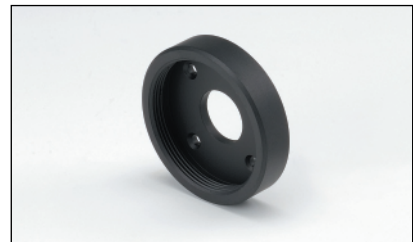
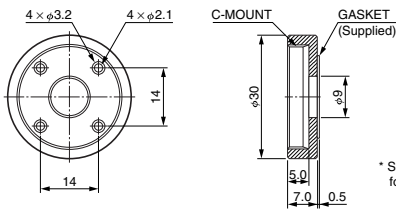

Note: Optical blocks are available for these photosensor modules to make compact optical systems without light leakage.

RELATED PRODUCT

POWER SUPPLY FOR PHOTOMULTIPLIER TUBE MODULES C10709

The C10709 is the power supply for photomultiplier tube modules which has 5 V output voltage.

This unit can provide both the driving voltage and the control voltage. This feature enables users to operate the modules easily.



Parameter	Description / Value	Unit
Output voltage	±5	V
Output current	Max. 2.0 (+5 V), 0.2 (-5 V)	A
Control voltage ^(A) (variable voltage range)	+0.25 to +1.8	V
Input voltage	AC100 to AC240	V

NOTE: ^(A) Adjust within the recommended control voltage range for the photomultiplier tube module being used.

HAMAMATSU PHOTONICS K.K. www.hamamatsu.com

HAMAMATSU PHOTONICS K.K., Electron Tube Division

314-5, Shimokanzo, Iwata City, Shizuoka Pref., 438-0193, Japan, Telephone: (81)539/62-5248, Fax: (81)539/62-2205

U.S.A.: Hamamatsu Corporation: 360 Foothill Road, Bridgewater, N.J. 08807-0910, U.S.A., Telephone: (1)908-231-0960, Fax: (1)908-231-1218 E-mail: usa@hamamatsu.com

Germany: Hamamatsu Photonics Deutschland GmbH: Arzbergerstr. 10, D-82211 Herrsching am Ammersee, Germany, Telephone: (49)8152-375-0, Fax: (49)8152-2658 E-mail: info@hamamatsu.de

France: Hamamatsu Photonics France S.A.R.L.: 19, Rue du Saule Trapu, Parc du Moulin de Massy, 91882 Massy Cedex, France, Telephone: (33)1 69 53 71 00, Fax: (33)1 69 53 71 10 E-mail: info@hamamatsu.fr

United Kingdom: Hamamatsu Photonics UK Limited: 2 Howard Court, 10 Tewin Road, Welwyn Garden City, Hertfordshire AL7 1BW, United Kingdom, Telephone: (44)1707-294888, Fax: (44)1707-325777 E-mail: info@hamamatsu.co.uk

North Europe: Hamamatsu Photonics Norden AB: Torshamnsgatan 35 SE-164 40 Kista, Sweden, Telephone: (46)8-509-031-00, Fax: (46)8-509-031-01 E-mail: info@hamamatsu.se

Italy: Hamamatsu Photonics Italia S.r.l.: Strada della Moia, 1 int. 6, 20020 Arese (Milano), Italy, Telephone: (39)02-93581733, Fax: (39)02-93581741 E-mail: info@hamamatsu.it

China: Hamamatsu Photonics (China) Co., Ltd.: B1201, Jianning Center, No.27 Dongsanhuan Beilu, Chaoyang District, Beijing 100020, China, Telephone: (86)10-6586-6006, Fax: (86)10-6586-2866 E-mail: hpc@hamamatsu.com.cn

Taiwan: Hamamatsu Photonics Taiwan Co., Ltd.: 8F-3, No.158, Section2, Gongdao 5th Road, East District, Hsinchu, 300, Taiwan R.O.C. Telephone: (886)03-659-0080, Fax: (886)07-811-7238 E-mail: info@tw.hpk.co.jp

TPMO1062E02
NOV. 2016. IP